

Powered by



HC 1217W ▶ 12V 17W

HC 1217W is specially designed for high efficient discharge application. Its invisible terminals can be inserted PC board directly. HC series battery can serve more than 260 cycles at 100 % discharge in cycle service, up to 5 years in standby service.



► Specification

Cells Per Unit	6
Voltage Per Unit	12
Capacity	17W @ 15min-rate to 1.67V per cell @25°C (77°F) 4Ah @ 20hr-rate to 1.75V per cell @25°C (77°F)
Weight	Approx.1.64 kg(3.62 lbs)
Maximum Discharge Current	60A(5sec)
Internal Resistance	Approx. 42mΩ
Operating Temperature Range	Discharge: -15°C~50°C (5°F~122°F) Charge: -15 °C~40°C (5°F~104°F) Storage: -15°C~40°C (5°F~104°F)
Nominal Operating Temperature Range	25°C±3°C (77°F±5°F)
Float Charging Voltage	13.5 to 13.8 VDC/unit Average at 25°C (77°F)
Recommended Maximum Charging Current Limit	1.7A
Equalization and Cycle Service	14.4 to 15.0 VDC/unit Average at 25°C (77°F)
Self Discharge	CSB Batteries can be stored for more than 6 months at 25°C (77°F). Please charge batteries before using. For higher temperatures the time interval will be shorter.
Terminal	C1-Faston Tab187/250
Container Material	ABS(UL 94-HB/File E50263)*Flammability resistance of (UL 94-V0/File E88637) can be available upon request.



MH14533(N)



ISO9001
No.:041005117



ISO 14001
NO.UM 1-12-0045

CSB-manufactured batteries are UL-recognized components under UL924 and UL1989. CSB is also certified by ISO 9001 and ISO 14001.

► Dimensions :

Unit: mm (inch)

Overall Height (H)	Container height (h)	Length (L)	Width (W)
103.5±1.5 (4.02±0.06)	102±1.5 (4.0±0.06)	139.7±1.5 (5.5±0.06)	48±1.0 (1.89±0.04)

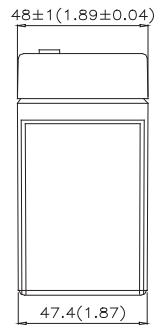
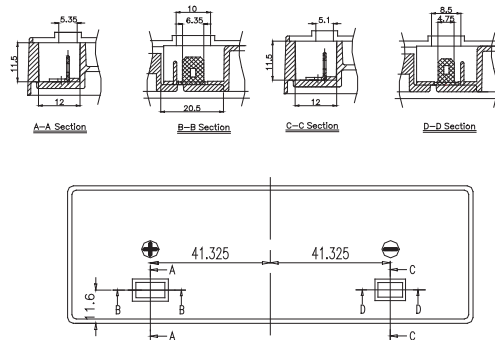
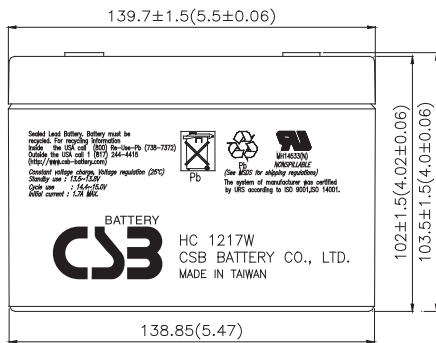

Constant Current Discharge Characteristics Unit:A (25°C, 77°F)

F.V/Time	2MIN	4MIN	6MIN	8MIN	10MIN	15MIN	20MIN	30MIN	60MIN	90MIN
1.60V	29.8	21.6	17.9	15.1	12.9	9.84	8.26	6.13	3.44	2.11
1.67V	27.8	20.5	17.1	14.5	12.6	9.59	8.08	6.03	3.38	2.07
1.70V	25.8	19.5	16.3	13.9	12.2	9.38	7.90	5.93	3.32	2.01
1.75V	23.9	18.3	15.3	13.3	11.7	9.12	7.69	5.82	3.26	1.95
1.80V	22.0	17.0	14.3	12.6	11.3	8.89	7.50	5.73	3.20	1.87
1.85V	20.1	15.6	13.2	11.9	10.7	8.57	7.25	5.61	3.14	1.80

Constant Power Discharge Characteristics Unit:W (25°C, 77°F)

F.V/Time	2MIN	4MIN	6MIN	8MIN	10MIN	15MIN	20MIN	30MIN	60MIN	90MIN
1.60V	358	257	215	179	152	117	99.1	73.5	41.3	25.3
1.67V	335	246	208	174	148	114	96.7	72.3	40.6	24.7
1.70V	310	233	197	166	142	111	94.0	71.2	39.8	24.0
1.75V	287	218	187	158	137	107	91.0	69.9	39.1	23.3
1.80V	265	203	173	150	131	104	88.2	68.7	38.4	22.4
1.85V	242	187	160	141	126	100	85.7	67.2	37.7	21.5

Trickle (or Float) Service Life

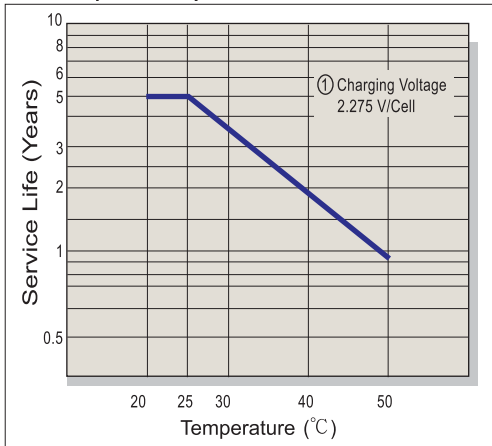

Capacity Retention Characteristic

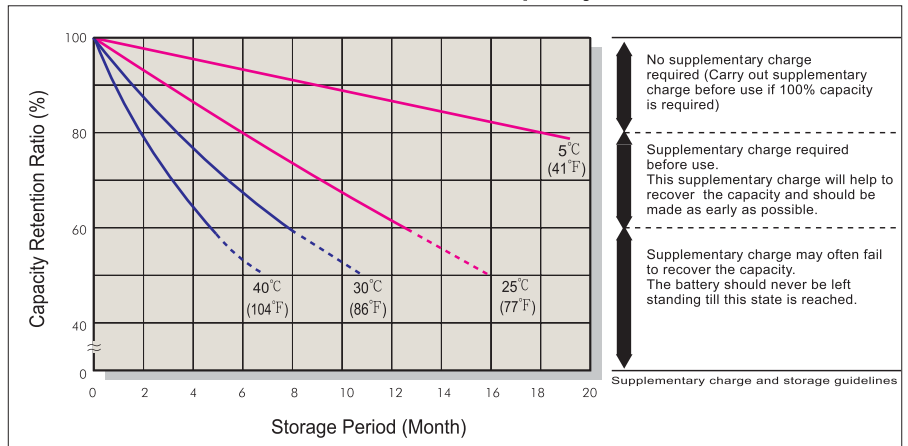

Battery Voltage and Charge Time for Standby Use

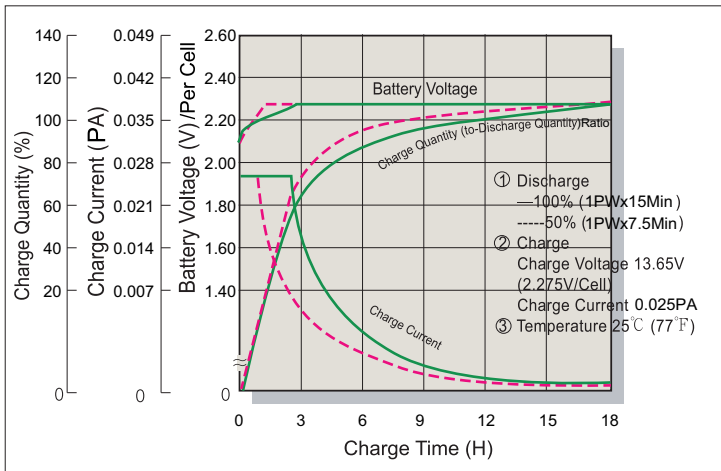

Cycle Service Life

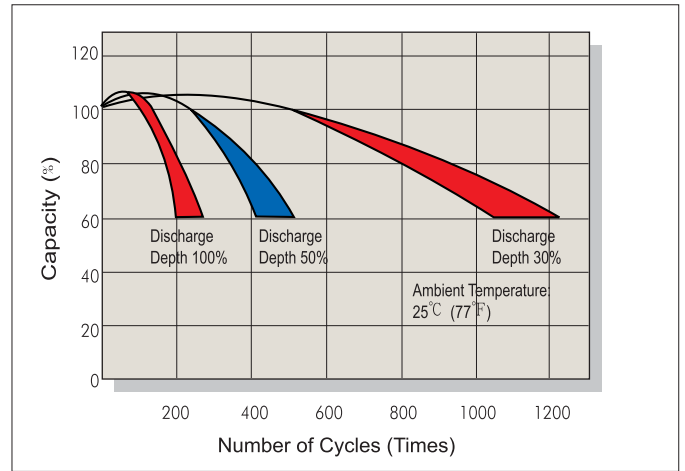

Battery Voltage and Charge Time for Cycle Use

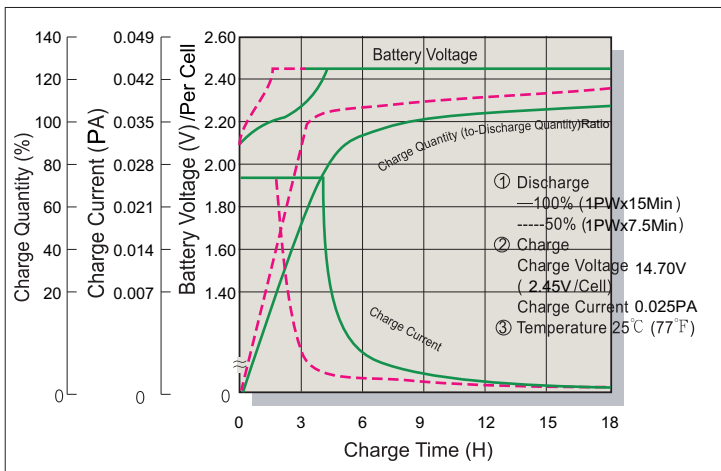

Terminal Voltage (V) and Discharge Time

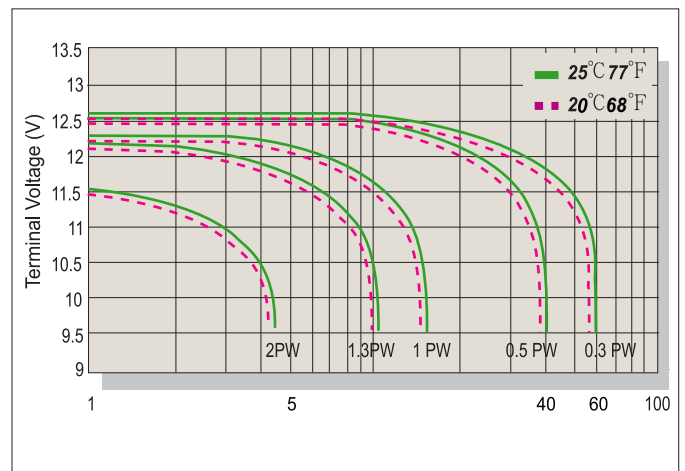

Charging Procedures

Application	Charge Voltage(V/Cell)			Max.Charge Current
	Temperature	Set Point	Allowable Range	
Cycle Use	25°C (77°F)	2.45	2.40~2.50	0.1PA
Standby	25°C (77°F)	2.275	2.25~2.30	

Discharge Current VS. Discharge Voltage

Final Discharge Voltage V/Cell	1.75	1.70	1.60	1.30
Discharge Power(W)	0.1P>(W)	0.1P≤(W)<0.25P	0.25P≤(W)<1.0P	(W)≥1.0P

Sales Office URL: WWW.CSB-BATTERY.COM

GLOBAL HQ
CSB BATTERY CO., LTD. (TAIWAN)
 Tel : +886-2-2555-5600
 Fax : +886-2-2555-3300
 mail : service@csb-battery.com.tw

BEIJING OFFICE. (CHINA)
CSB BATTERY TECHNOLOGIES (BEIJING) CO., LTD.
 Tel : +86-10-59621300/1301/1302/1303
 Fax : +86-10-59621304
 mail : chinasl@csb-battery.com

AMERICA HQ
CSB BATTERY TECHNOLOGIES INC. (U.S.A)
 Tel : +1-817-244-7777/1-(800)3-CSB-USA(272872)
 Fax : +1-817-244-4445
 mail : csb@csb-battery.com

SHANGHAI OFFICE. (CHINA)
CSB BATTERY LOGISTIC (SHANGHAI) CO., LTD.
 Tel : +86-21-5046-1622/5046-0833
 Fax : +86-21-5064-3314
 mail : chinasl@csb-battery.com

EUROPE HQ
CSB Battery Europe BV.
 Tel : +31(0)-180-418-140
 Fax : +886-2-2555-3300
 mail : eurosales@csb-battery.eu

SHENZHEN OFFICE. (CHINA)
CSB BATTERY LOGISTIC (SHANGHAI) CO., LTD.
 Tel : +86-755-8831-6488/6396/6356
 Fax : +86-755-8831-6548
 mail : she@csb-battery.com.cn